



**PROTECTION DEVICES**



  
PROTECTION DEVICES



An ISO 9001:2015 Certified Company



Switchgear & Protection Devices

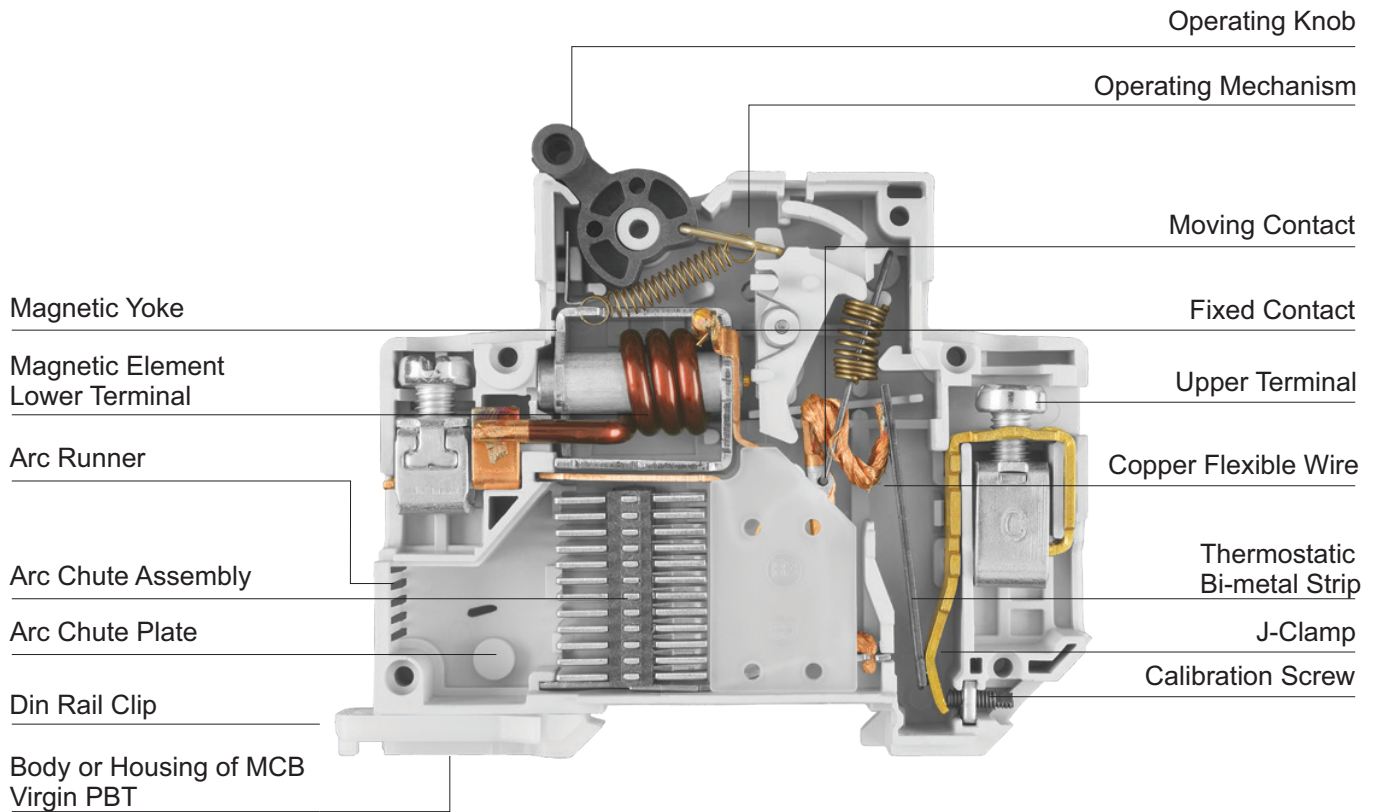

## THE TRIPPING MECHANISM OF MCB IS THERMAL MAGNETIC TYPE

Some of our special features are as follows:

- Plastic Body made from Special FR grade Virgin PBT.
- Bi-metal Inlay ( Copper plus Actual Silver Layer) for the tripping process.
- On - Off Indicator.
- Easy Mounting Feature.
- Heavy Duty Industrial Grade Changeovers.
- Heavy Duty Industrial Grade Earth Leakage Circuit Breakers.



## Your Safety is our Goal

CPL Protection Devices are made keeping just one thing in mind - SAFETY. This feature dominates our entire ethos while manufacturing our Miniature Circuit Breakers. While safety is important, we realize that a product must also have a certain ergonomic appeal as well, after all these products are made for people. Combining precise engineering, high quality raw material, and good design we have created a product that will ensure the protection your family deserves. Feel Safe with Our Protection Devices.

## MCB - MINIATURE CIRCUIT BREAKER



CODE	ITEM	MRP ₹	PKG.
<b>SINGLE POLE MCB (SP) "C" SERIES 10K</b>			
MCB6ASP	6 Amp Single Pole MCB	170.00	12
MCB10ASP	10 Amp Single Pole MCB	170.00	12
MCB16ASP	16 Amp Single Pole MCB	170.00	12
MCB20ASP	20 Amp Single Pole MCB	170.00	12
MCB25ASP	25 Amp Single Pole MCB	170.00	12
MCB32ASP	32 Amp Single Pole MCB	170.00	12
MCB40ASP	40 Amp Single Pole MCB	290.00	12
MCB50ASP	50 Amp Single Pole MCB	350.00	12
MCB63ASP	63 Amp Single Pole MCB	350.00	12



<b>SINGLE POLE MCB (SP) "C" SERIES 10K</b>			
MCB05ASP	0.5 Amp Single Pole MCB	300.00	12
MCB1ASP	1 Amp Single Pole MCB	300.00	12
MCB2ASP	2 Amp Single Pole MCB	300.00	12
MCB3ASP	3 Amp Single Pole MCB	300.00	12
MCB4ASP	4 Amp Single Pole MCB	300.00	12
MCB5ASP	5 Amp Single Pole MCB	300.00	12



<b>SINGLE POLE NEUTRAL MCB (SP+N) "C" SERIES 10K</b>			
MCB6ASPN	6 Amp Single Pole + Neutral MCB	450.00	06
MCB10ASPN	10 Amp Single Pole + Neutral MCB	450.00	06
MCB16ASPN	16 Amp Single Pole + Neutral MCB	450.00	06
MCB20ASPN	20 Amp Single Pole + Neutral MCB	450.00	06
MCB25ASPN	25 Amp Single Pole + Neutral MCB	450.00	06
MCB32ASPN	32 Amp Single Pole + Neutral MCB	450.00	06
MCB40ASPN	40 Amp Single Pole + Neutral MCB	650.00	06
MCB50ASPN	50 Amp Single Pole + Neutral MCB	750.00	06
MCB63ASPN	63 Amp Single Pole + Neutral MCB	750.00	06

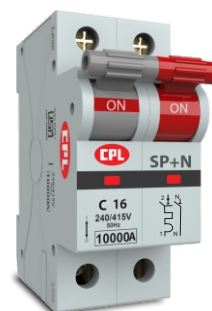

<b>DOUBLE POLE MCB (DP) "C" SERIES 10K</b>			
MCB6ADP	6 Amp Double Pole MCB	500.00	06
MCB10ADP	10 Amp Double Pole MCB	500.00	06
MCB16ADP	16 Amp Double Pole MCB	500.00	06
MCB20ADP	20 Amp Double Pole MCB	500.00	06
MCB25ADP	25 Amp Double Pole MCB	500.00	06
MCB32ADP	32 Amp Double Pole MCB	500.00	06
MCB40ADP	40 Amp Double Pole MCB	700.00	06
MCB50ADP	50 Amp Double Pole MCB	850.00	06
MCB63ADP	63 Amp Double Pole MCB	850.00	06

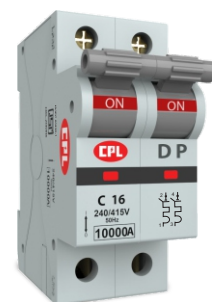



An ISO 9001:2015 Certified Company

CODE	ITEM	MRP ₹	PKG.
<b>DOUBLE POLE MCB (DP) "C" SERIES 10K</b>			
MCB05ADP	0.5 Amp Double Pole MCB	630.00	06
MCB1ADP	1 Amp Double Pole MCB	630.00	06
MCB2ADP	2 Amp Double Pole MCB	630.00	06
MCB3ADP	3 Amp Double Pole MCB	630.00	06
MCB4ADP	4 Amp Double Pole MCB	630.00	06
MCB5ADP	5 Amp Double Pole MCB	630.00	06



<b>TRIPLE POLE MCB (TP) "C" SERIES 10K</b>			
MCB6ATP	6 Amp Triple Pole MCB	750.00	04
MCB10ATP	10 Amp Triple Pole MCB	750.00	04
MCB16ATP	16 Amp Triple Pole MCB	750.00	04
MCB20ATP	20 Amp Triple Pole MCB	750.00	04
MCB25ATP	25 Amp Triple Pole MCB	750.00	04
MCB32ATP	32 Amp Triple Pole MCB	750.00	04
MCB40ATP	40 Amp Triple Pole MCB	1100.00	04
MCB50ATP	50 Amp Triple Pole MCB	1250.00	04
MCB63ATP	63 Amp Triple Pole MCB	1250.00	04

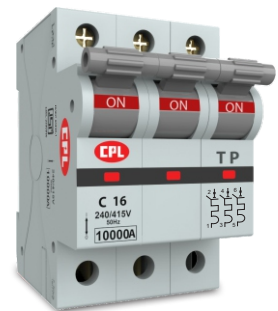

<b>TRIPLE POLE MCB (TP) "C" SERIES 10K</b>			
MCB05ATP	0.5 Amp Triple Pole MCB	1000.00	04
MCB1ATP	1 Amp Triple Pole MCB	1000.00	04
MCB2ATP	2 Amp Triple Pole MCB	1000.00	04
MCB3ATP	3 Amp Triple Pole MCB	1000.00	04
MCB4ATP	4 Amp Triple Pole MCB	1000.00	04
MCB5ATP	5 Amp Triple Pole MCB	1000.00	04



<b>FOUR POLE MCB (FP) "C" SERIES 10K</b>			
MCB6AFP	6 Amp Four Pole MCB	1150.00	03
MCB10AFP	10 Amp Four Pole MCB	1150.00	03
MCB16AFP	16 Amp Four Pole MCB	1150.00	03
MCB20AFP	20 Amp Four Pole MCB	1150.00	03
MCB25AFP	25 Amp Four Pole MCB	1150.00	03
MCB32AFP	32 Amp Four Pole MCB	1150.00	03
MCB40AFP	40 Amp Four Pole MCB	1400.00	03
MCB50AFP	50 Amp Four Pole MCB	1700.00	03
MCB63AFP	63 Amp Four Pole MCB	1700.00	03

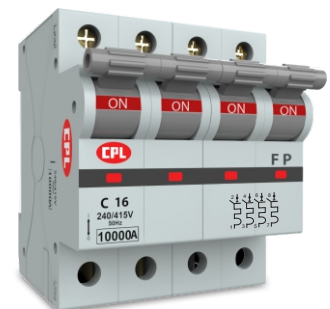

## MCB - MINIATURE CIRCUIT BREAKER



CODE	ITEM	MRP ₹	PKG.
<b>FOUR POLE MCB (FP) "C" SERIES 10K</b>			
MCB05AFP	0.5 Amp Four Pole MCB	1300.00	03
MCB1AFP	1 Amp Four Pole MCB	1300.00	03
MCB2AFP	2 Amp Four Pole MCB	1300.00	03
MCB3AFP	3 Amp Four Pole MCB	1300.00	03
MCB4AFP	4 Amp Four Pole MCB	1300.00	03
MCB5AFP	5 Amp Four Pole MCB	1300.00	03

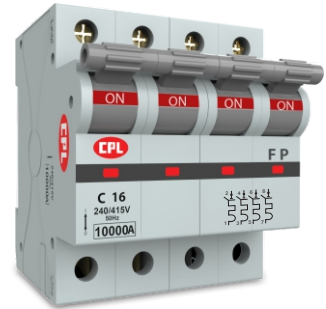

<b>TRIPLE POLE NEUTRAL MCB (TP+N) "C" SERIES 10K</b>			
MCB6ATPN	6 Amp Triple Pole + Neutral MCB	1000.00	03
MCB10ATPN	10 Amp Triple Pole + Neutral MCB	1000.00	03
MCB16ATPN	16 Amp Triple Pole + Neutral MCB	1000.00	03
MCB20ATPN	20 Amp Triple Pole + Neutral MCB	1000.00	03
MCB25ATPN	25 Amp Triple Pole + Neutral MCB	1000.00	03
MCB32ATPN	32 Amp Triple Pole + Neutral MCB	1000.00	03
MCB40ATPN	40 Amp Triple Pole + Neutral MCB	1300.00	03
MCB50ATPN	50 Amp Triple Pole + Neutral MCB	1500.00	03
MCB63ATPN	63 Amp Triple Pole + Neutral MCB	1500.00	03

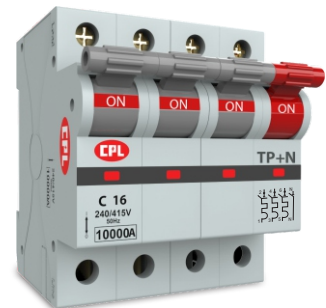

<b>MCB ISOLATOR</b>			
ISO40ADP	40A Isolator Double Pole	350.00	06
ISO63ADP	63A Isolator Double Pole	450.00	06
ISO100ADP	100A Isolator Double Pole	650.00	06



<b>MCB ISOLATOR</b>			
ISO40ATP	40A Isolator Triple Pole	550.00	04
ISO63ATP	63A Isolator Triple Pole	650.00	04
ISO100ATP	100A Isolator Triple Pole	900.00	04







An ISO 9001:2015 Certified Company

CODE	ITEM	MRP ₹	PKG.
<b>MCB ISOLATOR</b>			
ISO40AFP	40A Isolator Four Pole	750.00	03
ISO63AFP	63A Isolator Four Pole	850.00	03
ISO100AFP	100A Isolator Four Pole	1050.00	03

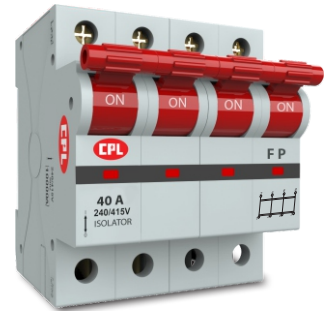

<b>CHANGEROVER</b>			
CGO40ADP	40A Changeover Double Pole	1100.00	06
CGO40AFP	40A Changeover Four Pole	2200.00	03





# Shielding Environment, Securing Lives



An ISO 9001:2015 Certified Company

CODE	ITEM	MRP ₹	PKG.
<b>Earth Leakage Circuit Breaker (ELCB/RCCB)</b>			
EL40A30DP	ELCB 40A Double Pole 30mA	2300.00	06
EL63A30DP	ELCB 63A Double Pole 30mA	3050.00	06
EL40A100DP	ELCB 40A Double Pole 100mA	2280.00	06
EL63A100DP	ELCB 63A Double Pole 100mA	3020.00	06
EL40A300DP	ELCB 40A Double Pole 300mA	2280.00	06
EL63A300DP	ELCB 63A Double Pole 300mA	3020.00	06



<b>Earth Leakage Circuit Breaker (ELCB/RCCB)</b>			
EL40A30FP	ELCB 40A Four Pole 30mA	2900.00	03
EL63A30FP	ELCB 63A Four Pole 30mA	3200.00	03
EL40A100FP	ELCB 40A Four Pole 100mA	2750.00	03
EL63A100FP	ELCB 63A Four Pole 100mA	3150.00	03
EL40A300FP	ELCB 40A Four Pole 300mA	2750.00	03
EL63A300FP	ELCB 63A Four Pole 300mA	3150.00	03



## ELCB/ RCCB - EARTH-LEAKAGE CIRCUIT BREAKER / RESIDUAL CURRENT CIRCUIT BREAKER

# DBs - DISTRIBUTION BOARDS



CPL **Distribution Boards** define simplicity, elegance and functionality. Designed to compliment the walls while making a style statement of its own. These DBs are made of high grade metal sheets that undergo anti rust smooth granular powder coating. Great care is taken to ensure that an even layer of powder coat is applied on the product to create the perfect aesthetic. "easy Locks" are provided for smooth functioning of the double door. "Bumpers" are given to ensure the edges of the DB never get damaged owing to wear & tear during use. Smooth colour combination ensures soothing feeling to the eyes and matches almost any wall/cabinet colour.





An ISO 9001:2015 Certified Company

CODE	ITEM	MRP ₹	PKG.
<b>DISTRIBUTION BOARDS SPN DOUBLE DOOR</b>			
DB4WSPN	4 Way SPN Double Door	1250.00	01
DB6WSPN	6 Way SPN Double Door	1700.00	01
DB8WSPN	8 Way SPN Double Door	1900.00	01
DB12WSPN	12 Way SPN Double Door	2200.00	01
DB16WSPN	16 Way SPN Double Door	2850.00	01

<b>DISTRIBUTION BOARDS TPN DOUBLE DOOR</b>			
DB4WTPN	4 Way TPN Double Door	3000.00	01
DB6WTPN	6 Way TPN Double Door	3600.00	01
DB8WTPN	8 Way TPN Double Door	4800.00	01

<b>DISTRIBUTION BOARDS SPN DOUBLE DOOR PLASTIC</b>			
DBPC4WSPN	4 Way SPN Double Door	510.00	01
DBPC8WSPN	8 Way SPN Double Door	660.00	01
DBPC12WSPN	12 Way SPN Double Door	810.00	01
DBPC16WSPN	16 Way SPN Double Door	1150.00	01

<b>AC BOX</b>			
ACBOX01	AC Metal Box	900.00	01

<b>AC Surface Box</b>			
CE 914	AC SURFACE BOX WITH MODULAR PLATE / 25A. UNIVERSAL SOCKET 25A. SP MCB & 25A. 3 PIN TOP WITH INDICATOR	550.00	5

<b>AC Box</b>			
CE 918	25A. AC BOX WITH 4 MODULAR PLATE/ 25A. UNIVERSAL SOCKET, 25A. SP MCB & 25A. 3 PIN TOP WITH INDICATOR	750.00	10



# Engineered for professionals



A hand in a blue suit sleeve points to a technical specification sheet for electrical components. The sheet includes the following information:

CODE	ITEM	PRICE
ISCHAMP	40A Isolator Four Pole	558.00
ISCHAMP	63A Isolator Four Pole	655.00
ISCHAMP	100A Isolator Four Pole	920.00
<b>CHANGEROVER</b>		
CGOAMP	40A Changerover Four Pole	1100.00
CGOAMP	63A Changerover Four Pole	2200.00
CGOAMP	100A Changerover Four Pole	2700.00

The sheet also features images of the electrical components and the 'CFL' logo.





An ISO 9001:2015 Certified Company

## **Giving you our best**

CPL has been extending innovative technology and luxury experiences for more than four decades. It is of utmost importance to us that we deliver nothing but the best to our customers. To do so we only work with suppliers that share our commitment of maintaining high quality. That is why our association has always been with talented, creative designers who have a responsible attitude towards design. And that is why we carefully select our suppliers so that we can work closely with them and supervise the whole production affair.

To achieve a perfect balance between carefully selected raw materials, beautiful design, functionality and good value is our motto. Every little piece, detail, line and material has been meticulously considered to ensure that the end result will work wonders in your home.

[www.cploriginal.com](http://www.cploriginal.com)



[www.cploriginal.com](http://www.cploriginal.com)

Mfg. By :

**CPL ELECTRICALS (INDIA) PVT. LTD.**

J. K. Industrial Compound, N.H. No.8, Near Novelty Hotel, Khairpada, Virar (E)  
Palghar - 401303 Contact : 7045685868 / 69, Email : [sales@cploriginal.com](mailto:sales@cploriginal.com)